



User Manual

Solius® Pro

Table of Contents

Device and Safety Information	3	Stopping therapy	27
Get Started	6	Therapy stopped due to distance sensor	28
Setup	8	Resuming therapy	28
What is in the box	8	Set a reminder for next therapy	29
Hanging the Solius Light Panel	8	Monitor therapy response	30
Setting the height of your device	11	Getting the Most Out of the Mobile App	31
Removing Solius Light Panel from a door	11	Troubleshooting	35
Turning Solius Light Panel On and Off	11	Glossary of Symbols	38
The Solius mobile app	12	Solius Light Panel Labels	40
Creating your profile	12	Frequently Asked Questions	42
Onboarding	13	Maintenance and Cleaning	45
Factors that may increase skin sensitivity	14	Technical Specifications	48
Personalized dose	15	Photosensitizing Agents	52
Resetting skin measurement	16	Cyber and Use Guidelines	55
Device status lights	17	EMC Declaration	60
Therapy Instructions	18	Electrical Warnings and Cautions	64
Therapy frequency	19		
Expose back of body	20		
Prepare for therapy	20		
Sign in your Solius account	20		
Clear the room	20		
Prepare therapy area	21		
Connecting to Solius Light Panel	22		
Measuring skin to determine exposure duration	23		
Solius glasses	25		
Start Therapy	26		
Position during therapy	26		
What to expect during therapy	27		

Device and Safety Information

Device and Safety Information

Device description

Solius Pro is a light panel with a controlled exposure of a targeted spectral output of ultraviolet B (UVB).

Indication for use

Solius Pro is an over-the-counter (OTC) light panel intended to stimulate the production of vitamin D in people 22 years and older.

Contraindications for use

Do not use the Solius Light Panel if:

- You have a history of underlying photosensitivity.
- You currently use any of the following photosensitizing medications orally or topically on the therapy area (back of torso from waist to neck): anti-convulsant, amiodarone, doxycycline, hydrochlorothiazide, methotrexate, naproxen, sulfa antibiotics, tetracycline, or tretinoin.
- You have been or become diagnosed with sensitivity or allergies to light affecting your skin, including but not limited to: actinic prurigo, chronic actinic dermatitis, lupus erythematosus, photodermatitis, polymorphous light eruption, protoporphyria, solar urticaria, UV-sensitive syndrome, vitiligo, or xeroderma pigmentosum.



WARNING: If you have been diagnosed with one of the listed conditions, using the Solius Light Panel may result in skin irritation. Consult your doctor if you are unsure.



WARNING: The Solius device is not intended to diagnose, treat, cure, or prevent disease, except for the indications for use described in the user manual for your applicable region. Solius does not provide specific medical advice to users. Users should seek advice from a qualified physician or healthcare provider. This User Manual does not establish a doctor-patient relationship. Consult the User Manual prior to first use.

Precautions

Evaluate whether the Solius Light Panel is suitable for you and consult your doctor if you have:

- A history of skin cancer, especially malignant melanoma or recurring basal or squamous cell carcinomas.
- Hyperthyroidism.
- A history of arsenic therapy, X-ray, or Grenz ray therapy.
- Active tuberculosis or other active infections or inflammatory conditions.
- Ongoing concomitant therapy (topical or systemic) with known photosensitizing agents for the therapy of cutaneous T-cell lymphoma.
- A wound or lesion on the therapy area.



WARNING: Prolonged exposure to ultraviolet light is associated with increased risk for the development of skin cancer. Users should be routinely evaluated for skin cancer by a medical professional. Solius is designed to reduce the risk of exposure to cancer-causing UV radiation compared to natural sun exposure.

Get Started

Get Started

Scan the QR code to get started

- 1 Download the Solius app, available on the Apple App Store.
- 2 Create an account and follow the on-screen instructions.



You must have secure internet access for the entire setup. For supported devices and operating systems, go to solius.com/compatibility.

User Manual Compatibility: **v0.10.3.37 device software or higher and v1.6 (4) iOS mobile app or higher.**

Customer support and resources

For user assistance, please contact Solius customer service at support@solius.com.

Email: support@solius.com

Web: solius.com

Copyright: © 2026, Solius Labs, Inc.
100 Ravine Lane NE, Suite 310
Bainbridge Island, WA 98110

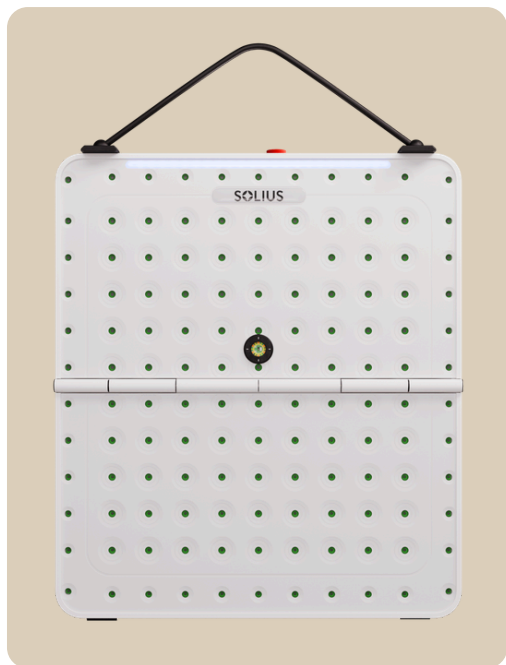

Setup

Setup

What is in the box

If you are missing or need replacements of any of these parts, please contact Solius Customer Service.

- Solius Light Panel
- Detachable 10ft power cord
- Complete Hanging system
- Skin measurement cone
- Protective eyewear



WARNING: No opening or modification of this equipment is allowed. The device has no serviceable parts. Tampering with the device may result in injury and will void the warranty.

Hanging the Solius Light Panel

The Solius Light Panel is designed to be hung on a door. Wherever you choose to use the Solius Light Panel, make sure there is an electrical outlet nearby.

Ensure the power plug, power button, and emergency stop button are easily accessible during use. As with other electronic devices, we recommend using the Solius Light Panel with a surge protector.

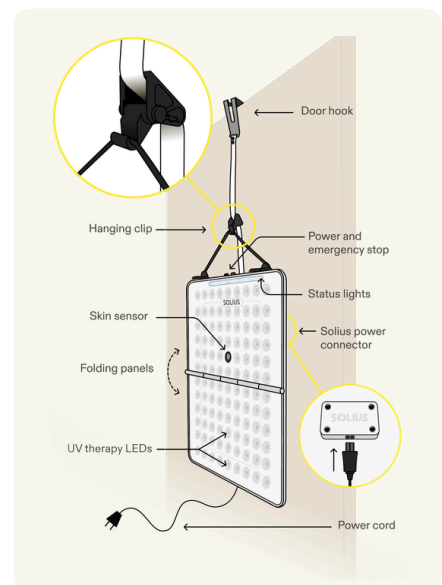

WARNING: Danger of choking. The power cord and hanging strap can choke babies, young children, or others who are not able to help themselves.

WARNING: If you cannot reach the top of the door safely, always use a sturdy, nonslip step stool with a wide base for stability.

1**Hang door hook.**

Place the door hook over the top of the door, centering it in the middle of the door, with the hanging strap lying flat against the door. Close the door to further secure the hanging setup.

**2****Adjust hanging clip to eye level.**

Adjust the hanging clip to eye level by sliding it along the hanging strap. The device weight will hold the clip in place.

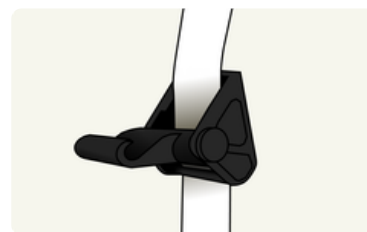
**3****Plug power cord into light panel.**

Plug the power cord into the port on the back of the light panel.

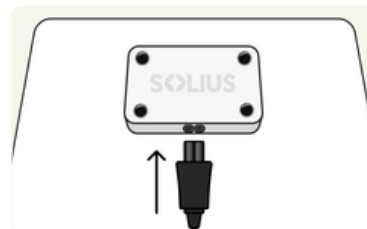
**4****Attach light panel to the hanging clip with latches facing toward you.**

Attach the light panel by placing the hanging cord onto the hanging clip, centering the panel by placing the black centering bracket on the hanging clip.

**5****Open light panel.**

Press down on the latches using your thumbs to gently fold the bottom panel of the device down and away from the top panel.

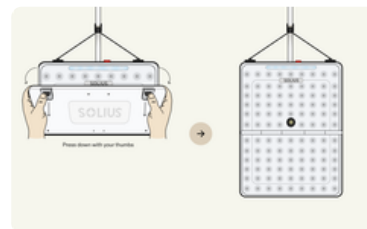
**6****Connect to power.**

Plug the power cord into a nearby outlet and remember to unplug the device when not in use.

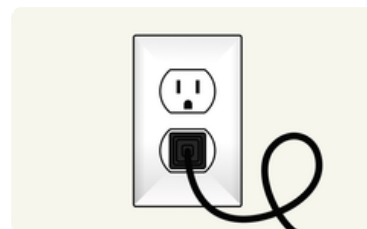

Setting the height of your device

The Solius Light Panel is optimized to target your torso. The top edge of the light panel should be at your shoulder height. Adjust the hanging clip to eye level before hanging the Solius device. Do not adjust the height of the light panel when it is hanging on the hanging clip.

Removing the Solius Light Panel from a door

- 1 Unplug the power cord from the outlet.
- 2 Gently fold the lower panel of the device into the top panel. Push the panels together until you hear the latches click.
- 3 Grasp both sides of the device and lift the device's hanging cord off the hanging clip.
- 4 Store the Solius Light Panel in a clean space where it will not be damaged or exposed to direct sunlight, water, or pests.



Turning the Solius Light Panel ON and OFF

To turn the Solius Light Panel ON, plug the end of the power cord into a power outlet, then press the power switch on the top middle of the device. The indicator lights at the top of the light panel will flash blue, then yellow, and then turn white and stay illuminated. At this point, the Solius Light Panel is ON and ready for Bluetooth pairing with the mobile app.

To turn the Solius Light Panel OFF, press the power switch on the top middle of the device again, or unplug the device from power.

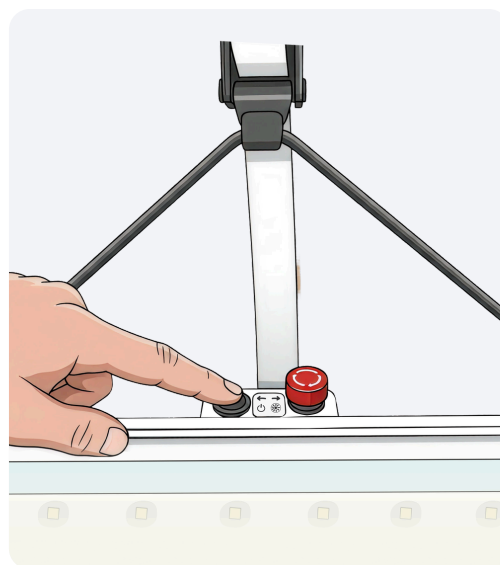

The Solius mobile app

The Solius mobile app is your therapy control center. The mobile app optimizes your personalized therapy settings and guides you through every step.

You must have secure internet access to create an account. For supported devices and operating systems, go to solius.com/compatibility.

Creating your profile

To use the Solius Light Panel, you must create a profile on the Solius mobile app.

- 1 Download the Solius app from the Apple App Store.
 - 2 Open the mobile app and tap **Get started**.
 - 3 Select your country code and enter your phone number.
 - 4 Review and agree to the Privacy Policy and Terms of Service.
 - 5 Confirm that you are at least 22 years of age.
 - 6 Enter your name and email and create an account password.
 - 7 Verify your account by typing in the code sent to your mobile device via SMS message and tap **Continue**.
 - 8 Review the safety warnings, contraindications for use, and the user manual. Then select the checkbox confirming “I have read and understand the User Manual,” and tap **Accept and continue** at the bottom of the screen if you understand and accept the warnings.
 - 9 Tap **Turn protection on** if you want to protect your account by using your fingerprint or face scan before therapy.
-  **You have successfully created your Solius account.**

Information: Your Solius account is personalized just for you. Never use another person’s account for therapy, and do not share your account with others. Using the wrong account can lead to the wrong dose. This may increase your risk of skin irritation. Do not allow unauthorized use of the Solius Light Panel. Use of the Solius Light Panel other than by intended users may result in hazardous UV light exposure.

Onboarding

After your account has been created, the mobile app will walk you through onboarding. It will show you how to set up your Solius Light Panel, measure your skin, and understand what happens during therapy. It will also explain how often to use the Solius Light Panel and how to adjust your dose. You must complete onboarding before your first therapy session. If you exit the mobile app without finishing, you will need to restart onboarding the next time you open the app.

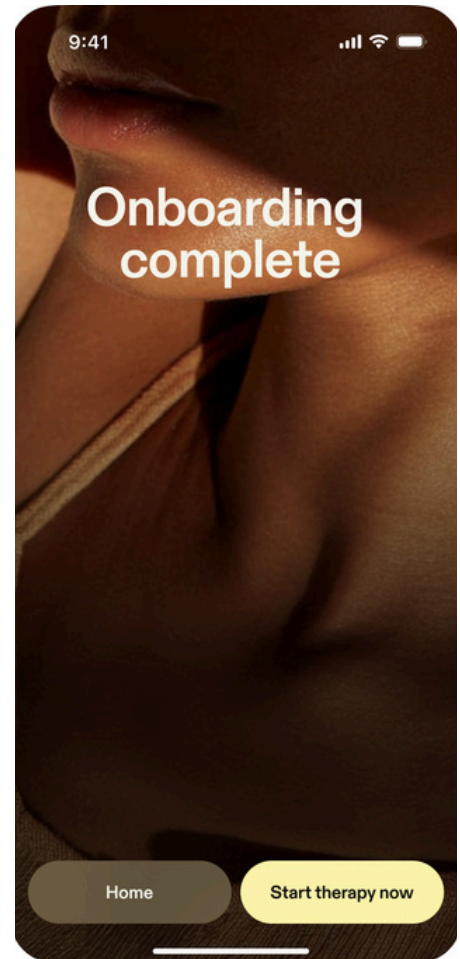
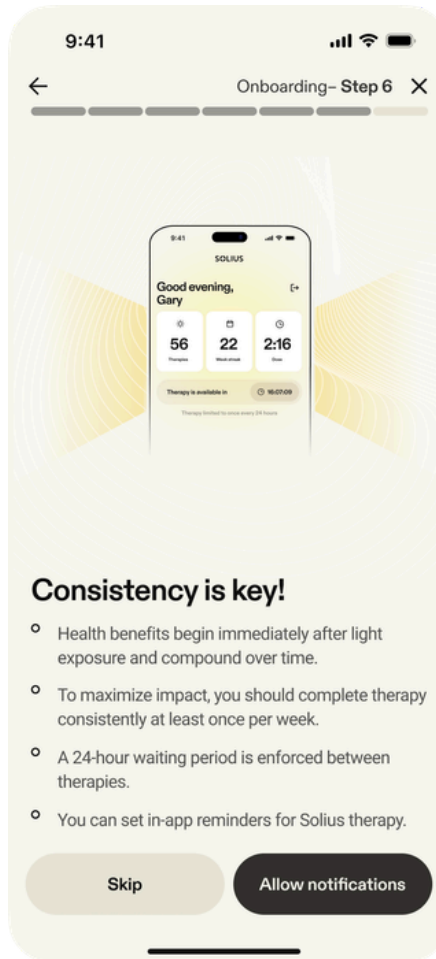

Factors that may increase skin sensitivity

See the **Photosensitizing Agents** section of this User Manual for a full list of medications and products.

You can still use the Solius Light Panel while using these products. Watch your skin for any reactions. If you report pinkness, redness, or irritation lasting more than 24 hours after therapy, the Solius mobile app will lower your dose.

CAUTION: Photosensitizing Agents

Using the Solius Light Panel while taking certain products and medications may increase your risk of skin irritation, including redness and itching. The following types of photosensitizing medications and topical agents may increase skin sensitivity and cause irritation:

- Acne.
- Anticancer.
- Antidepressants / Antianxiety.
- Antihistamines.
- Antihypertensives.
- Anti-inflammatory / Antiarthritic.
- Antibiotics / Antifungals / Antimicrobials.
- Antiparasitics.
- Antipsychotics.
- Contraceptives / Estrogens.
- Hypoglycemics / Antidiabetics.
- Oils (Perfumes / Cosmetics).



WARNING: Do not use the Solius Light Panel if the therapy area was exposed to significant sun in the past 24 hours, as this could increase the risk of skin irritation.

Personalized dose

Solius measures your skin prior to your first therapy to determine a safe and effective first dose. Solius begins with a conservative starting dose of 40% of your estimated maximum dose.

After your first therapy, you can adjust your personalized therapy dose based on your skin response.

Before each therapy, the Solius mobile app will ask if you experienced any pinkness, redness, or skin irritation lasting longer than 24 hours after your last therapy. If you answer “yes,” your therapy duration will be reduced by one level, which is 20%, and will stay at this lower level to help prevent future skin color changes or irritation.

If you did not experience any skin color change or irritation after therapy, you can gradually increase your exposure duration in 20% increments, based on peer-reviewed dermatology research and established clinical guidelines.

To reach your maximum dose, increase levels until you notice a mild, warm pinkness in your skin — a sign your body has reached its most effective level. You must complete a therapy between each dose level increase to see how your skin responds to the longer duration. Most users reach their maximum dose within five increases, but everyone’s skin is different.

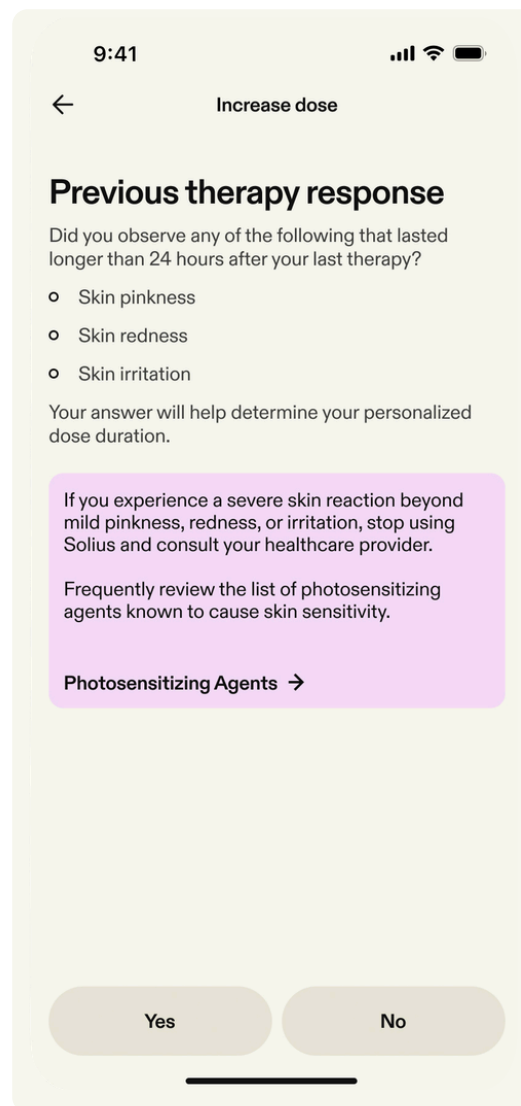

Please note that Solius therapies are powerful. Increasing duration may increase the potential health impact of Solius, but also increases the risk of skin pinkness, redness, or irritation.

You can also adjust your therapy duration outside the therapy workflow by opening your **Profile** tab and tapping **Personalized dose**. From this page, you can increase or decrease your therapy by one level.

Resetting skin measurement

To reset your skin measurement, open the **Profile** tab in the mobile app. Tap **Personalized dose > Reset skin measurement**. This will clear your previous skin measurement, dose adjustments, and any dose limits. The app will then ask you to take a new measurement. We suggest taking a new measurement if you notice changes in your skin. For example, if you get a summer tan or if you have not used the Solius Light Panel for a long time.

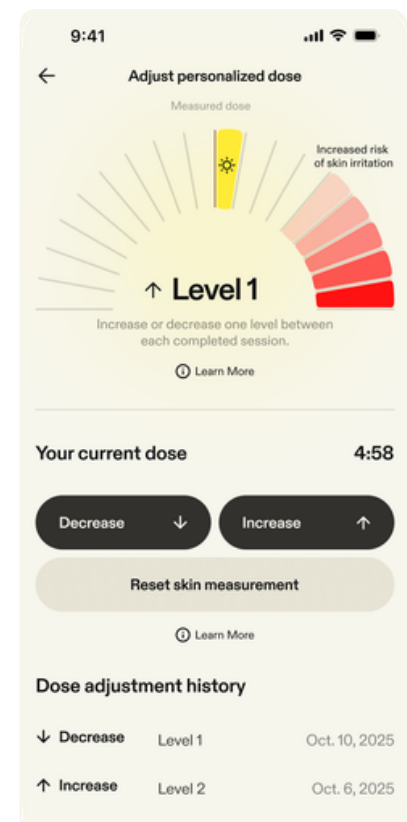
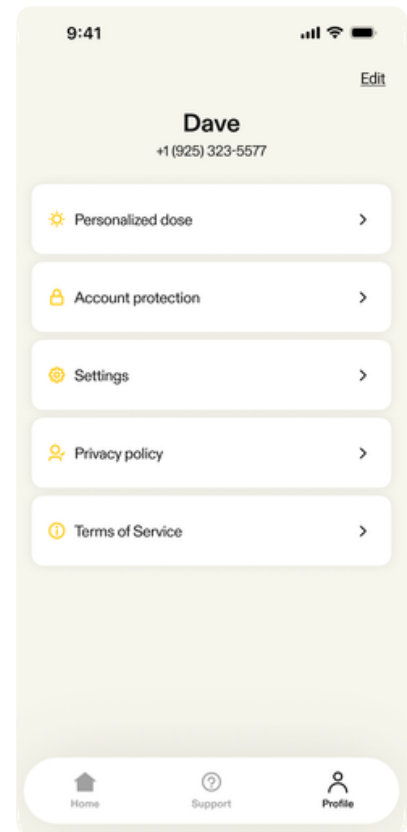

Device status lights

The Solius Light Panel uses different colored lights across the top of the device to communicate information about the device's status. The device has the following color indicators:

Flash of Blue, Yellow, White: Device power turned ON.

White: Device is in stand-by mode and waiting for Bluetooth connection.

Blue: Device Bluetooth is connected to the Solius mobile app.

Yellow: UVB therapy is in progress (the UVB lights are not visible).

Solid Red: Device is in error mode.

Flashing Red: Emergency stop button is pressed.

Blue Lights Increasing Left to Right: Device software update in progress.

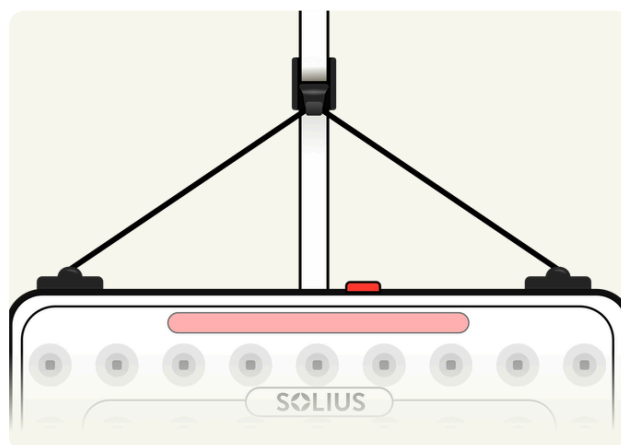
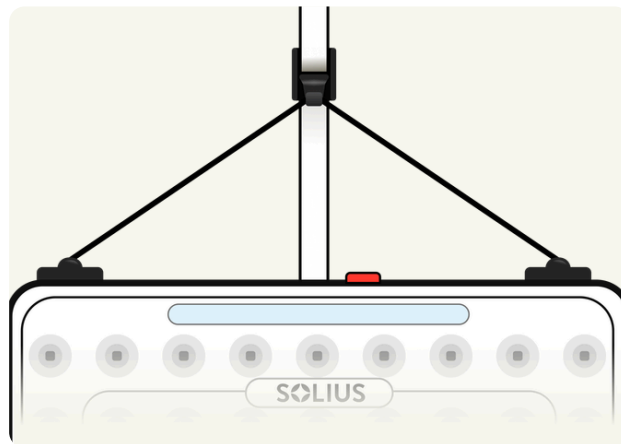

Therapy Instructions

Therapy Instructions

Please read this section before starting therapy, and refer to it if you have any questions. The topics in this section appear in the order that you will encounter them as you begin therapy.

Hold your mobile device during therapy sessions so the app can guide you through setup and provide real-time distance feedback during your therapy.

Therapy frequency

To stimulate the production of vitamin D, users should complete therapy consistently at least once per week.

A 24-hour waiting period between therapies is enforced to ensure your safety and confirm your body does not negatively react to the prior therapy session.

When you log in to the Solius mobile app, the **Home** tab will display if therapy is available or when you will be able to initiate your next therapy. A calendar showing your therapy **History** is also available on the mobile app.

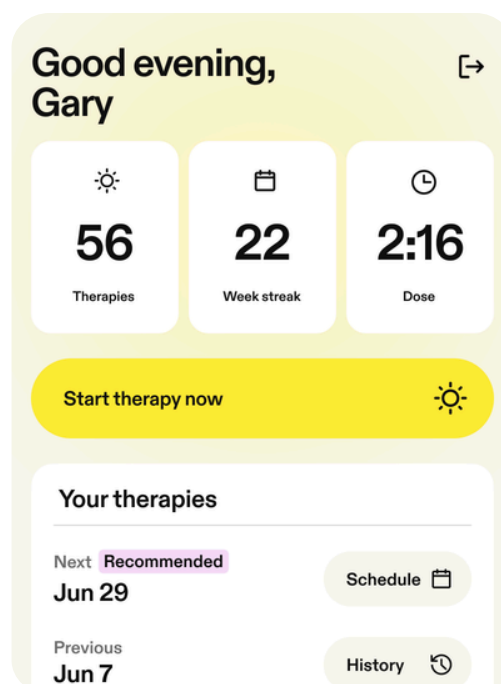

WARNING: Do not use the Solius Light Panel if therapy area was exposed to significant sunlight in the past 24 hours, as this could increase the risk of skin irritation.

Expose back of body

The Solius Light Panel is designed to treat the back of your body. During therapy, position yourself with your back centered in front of the light panel so the light can directly reach the skin on your upper and lower back.

Do not face the Solius Light Panel during therapy. Facing toward Solius makes it harder to maintain a consistent distance and positioning, increases the risk of unintended eye and face exposure, and can interfere with accurate dosing when hands and phones partially block the light panel.

Prepare for therapy

Create an account on the mobile app according to the instructions in the **Setup** section of this User Manual.

Sign in your Solius account

- 1 Open the Solius mobile app on your mobile device.
- 2 Tap **Sign in**.
- 3 Enter your phone number and password and tap **Continue**.

Clear the room

Before starting therapy ensure the room is free of other people and pets to prevent eye damage.

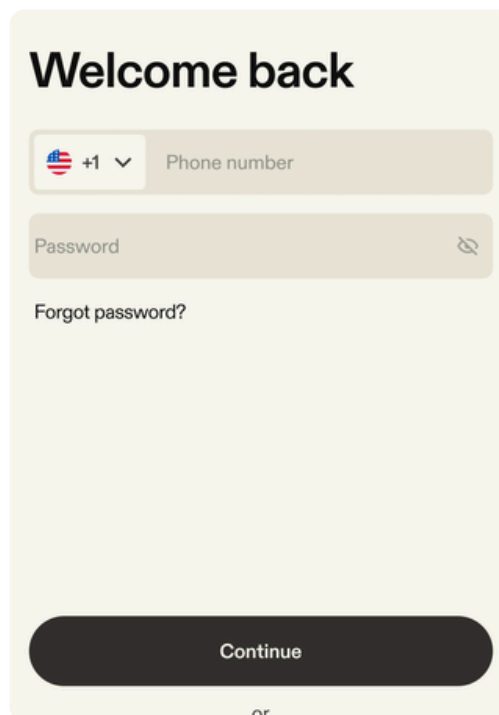

Prepare therapy area

To effectively stimulate your skin's natural production of vitamin D, the Solius Light Panel must shine directly on bare skin. Please follow these steps before starting your session:

- **Undress the upper body:** Remove clothing from your torso (waist to neck) to expose the therapy area. A bra may be worn, however, more exposed skin improves effectiveness. Keep lower-body clothing on to protect the genitals.
- **Adjust hair:** Move any long hair away from your back to ensure the skin is fully exposed.
- **Avoid skin products:** Ensure your back is free of products such as sunscreen, lotion, or body oils.

Sunscreen will prevent your skin from making vitamin D, and certain lotions and oils may include ingredients that make your skin more photosensitive and susceptible to irritation.

See the **Photosensitizing Agents** section of this User Manual for a full list of photosensitizing medications and products.



WARNING: Exposure of the genitals to UV light may increase the risk of skin cancer.

WARNING: Do not use Solius Light Panel while wearing any topical lotions, creams, oils, or cosmetics on the therapy area.

Connecting to Solius Light Panel

Make sure the Solius Light Panel is set up, turned on, and near your mobile device. Sign in to the Solius mobile app and tap **Start therapy now**. The mobile app will start scanning for nearby Solius Light Panel devices and will automatically connect to the closest device. Once your Solius Light Panel and mobile app are connected via Bluetooth, the indicator lights at the top of the light panel will turn from white to blue.

If your mobile app shows the Solius Light Panel as connected but your light panel doesn't display blue lights, your mobile app may have connected to another device in the area. If this happens, force quit the mobile app, move your mobile device closer to your light panel, and try connecting again. Only one mobile device can be connected to the Solius Light Panel at a time.

If your Solius Light Panel displays blue lights but your mobile app does not show that SOLIUS is connected, someone in the area may have connected to your device. If this happens, turn your device off and back on, move your mobile device closer to your light panel, and try connecting again.

Once the indicator lights illuminate blue, follow the instructions to begin therapy.

Once therapy is complete, paused, or stopped for any reason, the Bluetooth connection between the Solius Light Panel and mobile app will automatically disconnect.

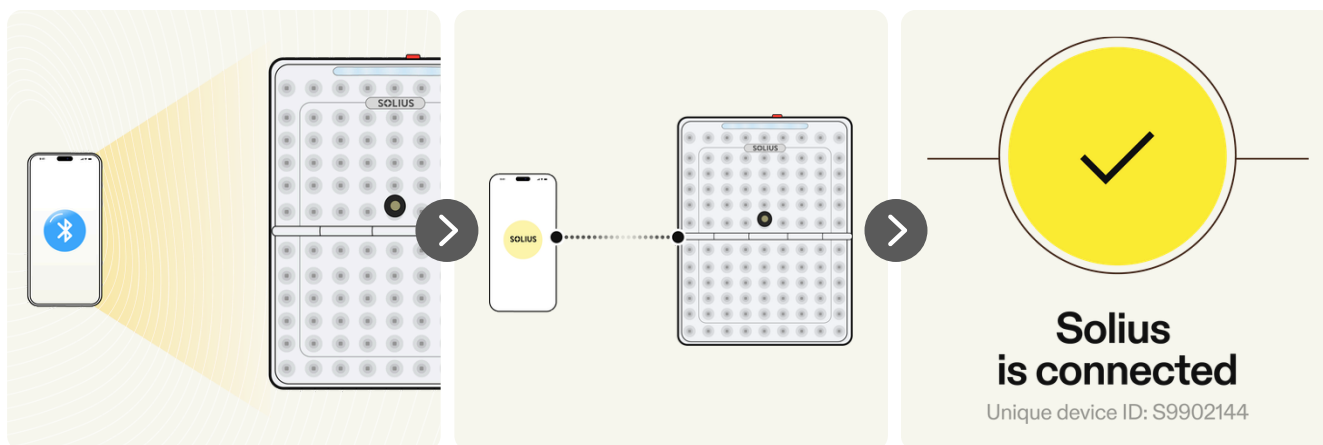

Measuring skin to determine exposure duration

Your optimal therapy time depends on factors like skin color and sensitivity. The Solius mobile app will ask a brief question about your UV sensitivity and skin history, then guide you through a simple measurement. The Solius Light Panel uses a built-in sensor to measure your skin and set a personalized duration before your first therapy. Before taking a measurement, ensure the skin sensor is clean. See the **Maintenance and Cleaning** section of this User Manual for cleaning instructions.



- 1** Attach the skin measurement cone via magnets to the skin sensor on the Solius Light Panel.

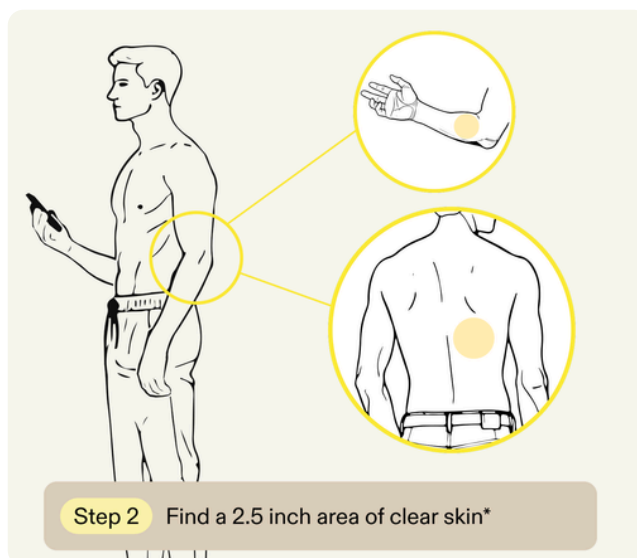

- 2** Find a clear area of skin on your back, avoiding tattoos, birthmarks, scars, moles, and thick hair. Adjust the height of the light panel if necessary.

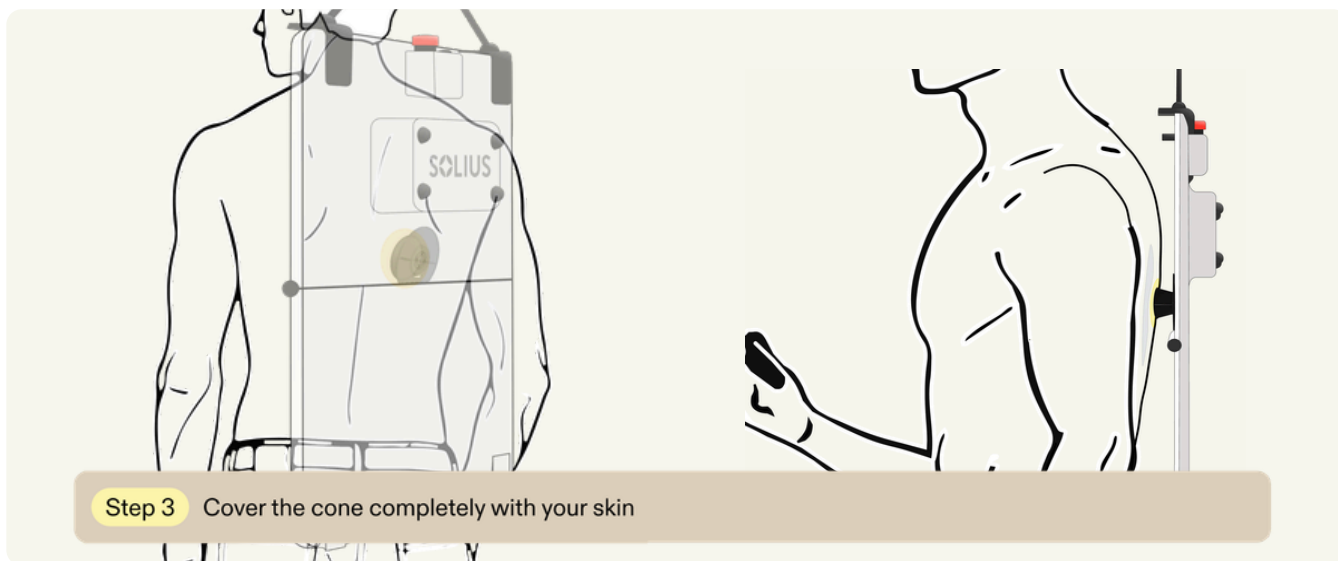

3 Face away from the light panel and position the clear area of skin on your back lightly against the measurement cone.

Ensure your skin completely covers the measurement cone.

When you are in the proper position, tap **Start measurement**.
Stand still while the skin sensor takes the measurement.

If you don't have a clear spot on your back that meets the rules above, use your inner forearm, just below your elbow, instead. Make sure the skin is flat and clear.

Before you take the skin reading, let your skin warm up to room temperature. This helps avoid color changes from being too hot or too cold. Also, make sure there are no marks on the skin from clothes or furniture.

Once the measurement is complete, the Solius mobile app will automatically calculate and display your therapy duration. After your first therapy, you do not need to take another skin measurement.

Solius glasses

It is mandatory that you wear protective eyewear during therapy. UVB light is invisible to the human eye and can cause permanent eye damage.

Similar to how you avoid looking directly at the sun, you should avoid looking directly into the Solius lights during therapy. The yellow light emitting from the top of the Solius Light Panel is simply an indicator light to let you know that the UVB lights are on.

The Solius Light Panel must be used with the included Solius glasses. For your safety, before beginning therapy, the Solius app will scan your face to verify that you have the Solius glasses on and that they are in a safe position covering both eyes.

In order to perform this scan, the Solius app will need access to your mobile device camera. Solius does not capture or save images during this scanning process. If you do not allow the Solius app to access your mobile device camera, you will not be able to use the Solius Light Panel.

If the mobile app cannot detect your Solius glasses during your scan or if the glasses are not positioned safely to cover both eyes, the app will ask you to restart the scan until safe glasses placement can be verified.

Keep the Solius glasses on for the full duration of your therapy until the UV lights turn off.



WARNING: Keep eyewear on throughout therapy. Failure to wear the eye protection provided for the entire therapy may lead to serious and lasting eye damage, such as photokeratitis, photoretinitis, and cataracts.

Starting therapy

Once you confirm that you have your eyewear on, you can start the therapy from the mobile app. Slide the **Start therapy** button to begin therapy. A three-second countdown will begin on the app before the UV lights turn on. The timer display on the app will start counting down to show how much time is remaining in your therapy.

Position during therapy

For optimal results, stand with your back centered between **7–14 inches away from the Solius Light Panel during therapy**. The device has a distance sensor that will display your real-time distance from the light panel and notify you if you are too close, too far, or at the correct distance from the device.

To ensure safety, if you are too close to the device for more than 5 seconds or too far from the device for more than 15 seconds, the therapy will be terminated. Audible beeps from the device and on-screen prompts in the mobile app will guide you to the correct position to optimize your therapy session.

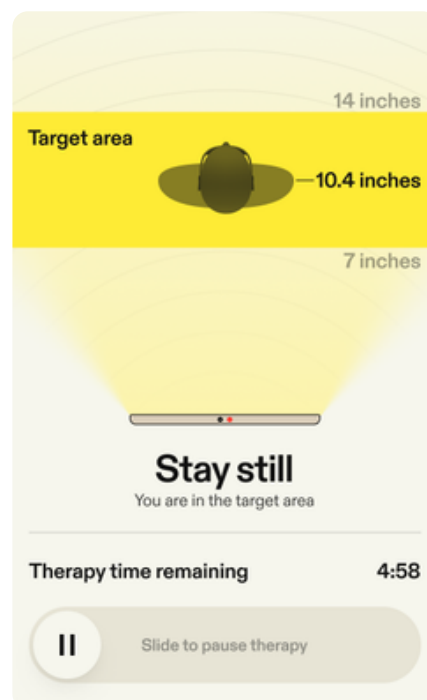



What to expect during therapy

When the UV lights turn on, the Solius Light Panel indicator lights will illuminate yellow. Since UV light is invisible to the human eye, you will not see light emitting from the UV LED therapy lights. The visible colored lights on the light panel are not therapy lights. They serve as a visual indicator that the UV lights are on.

Stopping therapy

-  **Therapy Complete**
Therapy will stop, and the UV lights will turn off automatically once your therapy timer reaches zero.

-  **Pausing Therapy**
If you need to stop your therapy before the timer reaches zero, you can slide the pause button at the bottom of the screen. The mobile app will bring you back to the **Home** tab, where you can restart your remaining therapy duration when you are ready.

-  **Emergency Stop Button**
You can also stop your therapy by pressing the red emergency stop button on the top of the light panel. When you press the emergency stop button, the UV lights will immediately turn off, and the indicator lights on the device will flash red. In order to restart a therapy after hitting the emergency stop button, you will need to release the emergency stop by turning the red emergency stop button clockwise until the button pops back up.

Therapy stopped due to distance sensor

Therapy will also stop if you are not in the correct position. During therapy, you must stand 7–14 inches away from the device. If you are outside of this distance range, the light panel will audibly beep, and the mobile app will notify you which direction and how far to move to get in position 7–14 inches from the light panel. If you are too close to the device for more than 5 seconds or too far from the device for more than 15 seconds, the therapy will be terminated. Standing too close to the light panel during therapy may cause skin irritation, and standing too far from the light panel during therapy will reduce the effectiveness.

Resuming therapy

If your therapy is paused or stopped for any reason before the therapy timer reaches zero, you can restart your remaining therapy time. After a therapy is stopped, the remaining therapy time will be displayed on the mobile app **Home** tab. To restart your remaining therapy time, tap **Resume therapy** from the **Home** tab. You will be able to restart a remaining therapy for up to 16 hours after the original start time of the therapy. If you do not restart your remaining therapy time, the therapy will time out after 16 hours, and you will be able to start your next full therapy after the 24-hour lockout period.

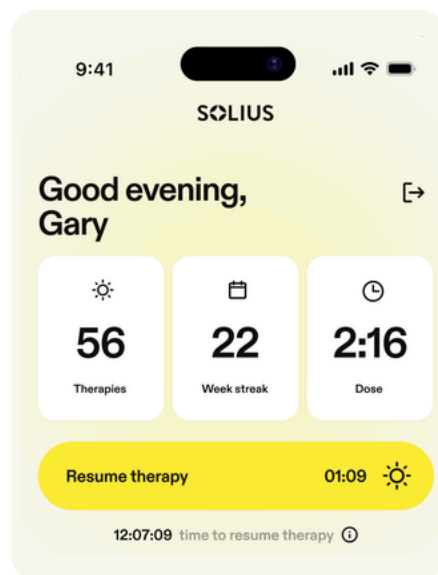
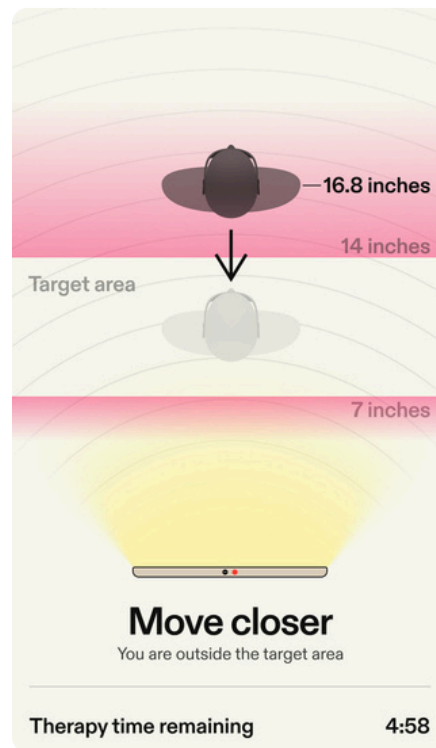

Set a reminder for next therapy

After you complete therapy, the Solius mobile app will ask if you want to schedule your next therapy. You can also schedule therapy from the mobile app **Home** tab by tapping **Schedule** under the recommended next therapy date.

To schedule a therapy, the Solius mobile app will allow you to select the date and time for your next therapy and add the therapy to your calendar. When you are selecting the date, the calendar will indicate the recommended next therapy date one week from your last therapy. This recommended date will be shown with a lilac outline. You can choose the recommended therapy date or schedule your therapy for any date that works for your schedule, as long as it is 24 hours after your last therapy. Once you schedule a therapy, that date will be circled in yellow.

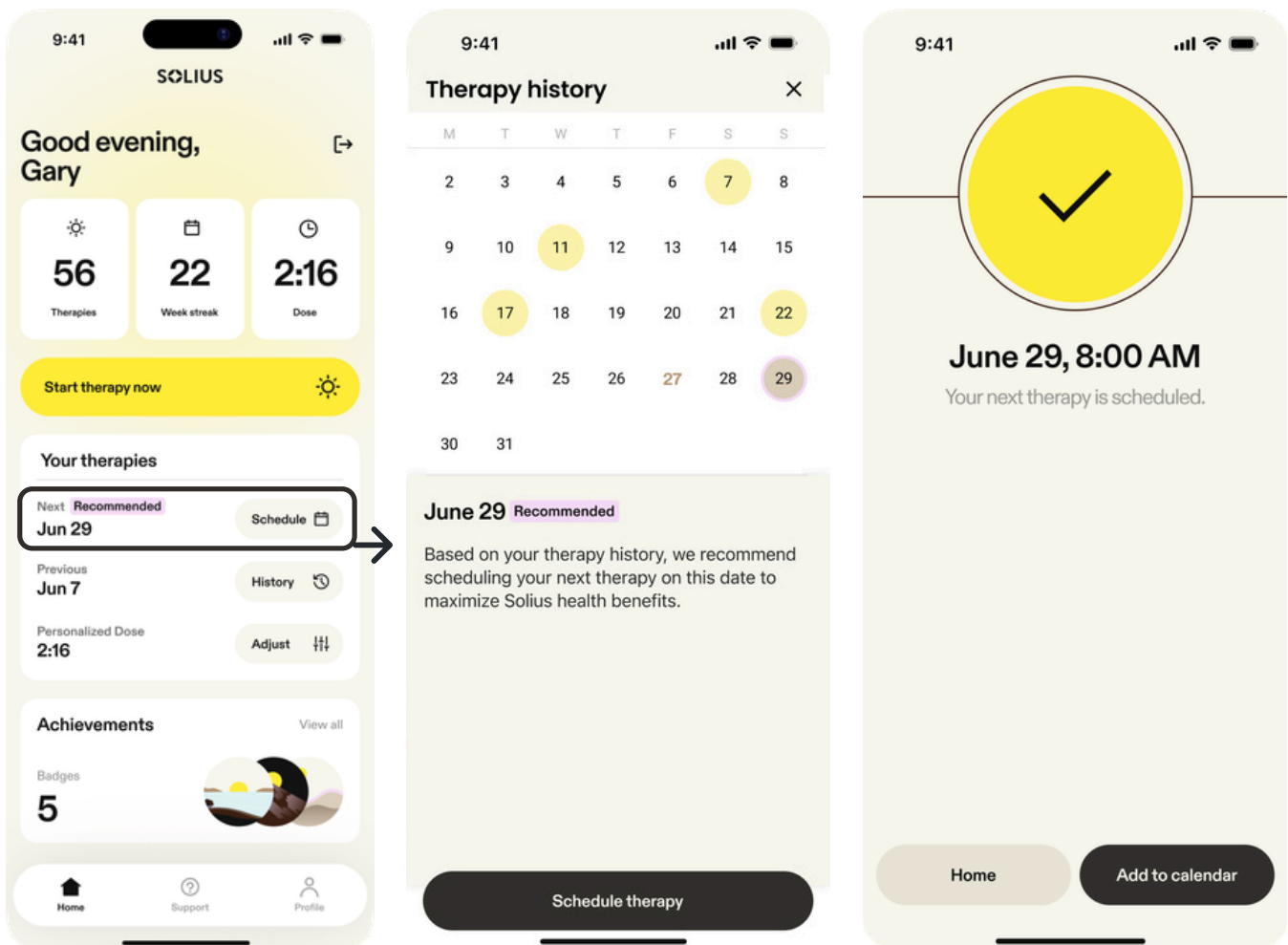

Monitoring your skin's response

The Solius Light Panel is designed to minimize risk, however you should closely monitor your skin's reaction while using the device. While UVB exposure is associated with benign skin darkening and skin aging, the Solius Light Panel is designed to not cause skin color change. You may experience skin redness but this normally goes away within 24 hours.

Prior to therapy, you will be asked to respond to a skin response question to understand if you experienced any pinkness, redness, or skin irritation that lasted more than 24 hours after your last therapy. If you answer “yes” to this question, your future therapy durations will be reduced to prevent further occurrences of skin color change or irritation.

There is minimal risk of serious adverse reactions associated with severe irritation, such as skin blisters, pain, and itchiness. To minimize the risk of the above adverse reactions, your skin color will be measured to determine an individualized therapy duration of UVB light that is appropriate for your skin. If you experience a severe reaction after therapy that causes pinkness, redness, or skin irritation with severe pain, stop using the Solius Light Panel immediately and consult your healthcare provider. Indications of a severe reaction include severe pain, edema, skin peeling, or blisters. If this occurs, please promptly contact our customer service team at support@solius.com.

Do not use the Solius Light Panel if you are currently experiencing skin irritation or color change from a prior therapy. Wait until skin has returned to a normal color before using the Solius Light Panel. Using the Solius Light Panel while still experiencing pinkness, redness, or skin irritation may increase your probability of a more severe reaction.



WARNING: Do not use the Solius Light Panel if you are currently experiencing skin irritation or color change from a previous therapy, as this could increase the risk of further skin irritation.

Getting the Most Out of the Mobile App

Getting the Most Out of the Mobile App

In addition to being your therapy controller, the Solius mobile app has various features to help you maintain a consistent therapy schedule. Use the navigation bar at the bottom of the screen to navigate through the mobile app.

Achievements

Using the Solius Light Panel consistently is critical for optimizing health outcomes. As you use the Solius Light Panel, you will earn badges for maintaining a consistent therapy schedule, having therapy at different times of day, and more! Badges will be displayed on your mobile app **Home** tab, and your accomplishments can be shared with friends on social media.

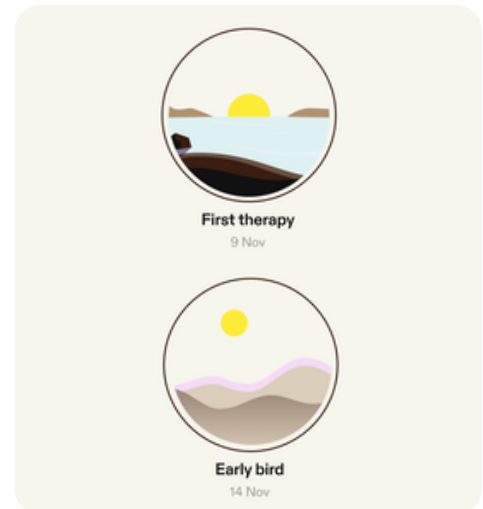

Profile tab

You can view and edit your user profile by tapping **Profile** on the mobile app navigation bar.

In the **Profile** tab, you can:

- Edit the name and email associated with your account.
- Set up a biometric sign-in.
- Change your password.
- Adjust your language, sound, and measurement preferences.
- View and edit your dose adjustment history.
- View your Solius app and device software versions to see if an update is needed.
- View the Privacy policy and Terms of Service.
- Delete your account.

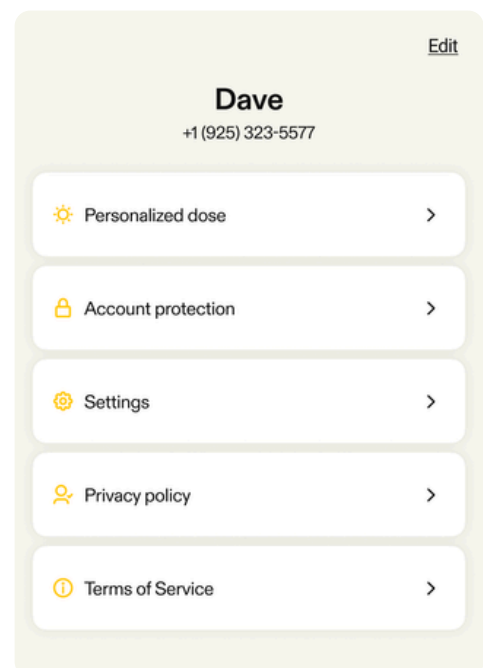

Therapy history calendar

You can view your past therapy sessions from the **Home** tab. Days with completed therapy are marked with a filled yellow circle. Tap any marked day to see detailed session information, including:

- **Therapy Dose:** The personalized duration set for that therapy.
- **Therapy Duration Run:** The total amount of therapy time completed.
- **Sessions:** The number of sessions it took to complete the therapy (e.g., If you pause a therapy, and then resume and complete the therapy, that is two sessions.)
- **Therapy Timespan:** The total time from the start of the first session to the end of the latest session.
- **Dose Adjustment:** The dose adjustment level used for this session.
- **Device ID:** The unique ID of the Solius Light Panel used.
- **Device Software Version:** The software version installed on the device during therapy.

If a therapy was completed across multiple sessions, you can tap into each session to view the duration of that session and the reason the session ended.

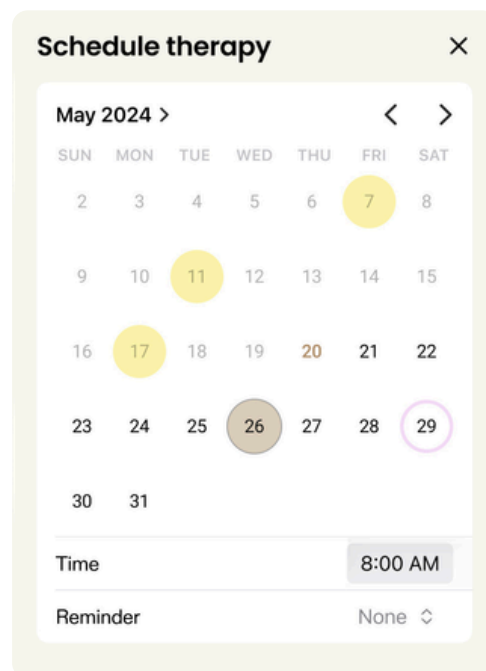

Updating device software

If a device software update is available for the light panel, the mobile app will notify you once you connect your Solius Light Panel to Bluetooth. When the mobile app prompts you to update your device software, you can start the update right away or delay it for one therapy. If you choose to delay the update, the mobile app will require you to complete the device software update the next time you connect to the Solius Light Panel.

You can also start a device software update by going to the **Profile** tab and tapping **Settings > Device Software Update**. The mobile app will prompt you to connect to your device via Bluetooth and then display an **Update now** button if a device software update is available. During the update, please keep your mobile device near the Solius Light Panel. The update will take approximately six minutes.

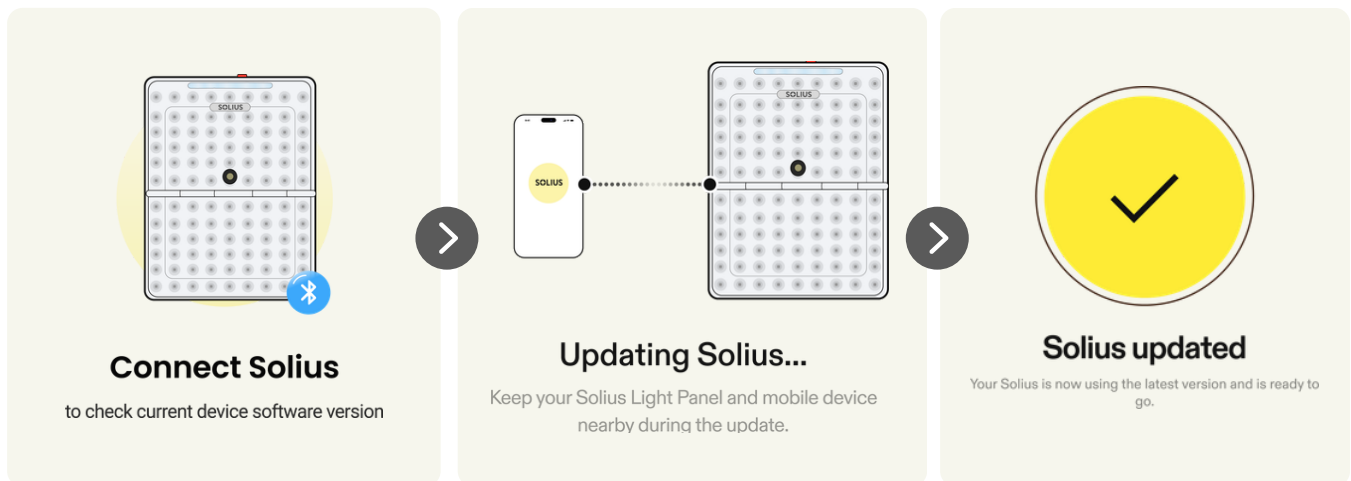

Troubleshooting

Troubleshooting



The mobile app will notify you if the Solius Light Panel is in an error state and how to solve the problem. Below is a list of some potential error screens you may see. If the troubleshooting steps below do not resolve the issue and the Solius Light Panel remains in an error state, please contact Solius Customer Service at support@solius.com.

Error Screen	Solution
Solius error	<ul style="list-style-type: none"> • Press power button to turn Solius OFF. • Wait for 5 seconds. • Press power button again to turn Solius ON.
Solius needs to warm up	The light panel is being used in too cold of an environment. Turn Solius OFF and restart therapy in an environment warmer than 41° F (5°C).
Solius needs to cool down	The light panel is being used in too hot of an environment. Turn Solius OFF until cool and restart therapy in an environment cooler than 113° F (45°C).
Solius not found	The light panel was unable to connect to Bluetooth. Please ensure Solius is plugged in, powered ON, and near your mobile device, before trying to reconnect.
Solius is not hanging correctly	The light panel is not hanging correctly. Ensure Solius is hanging vertical, fully opened, and level, then try to restart therapy.
Bluetooth connection lost	Bluetooth disconnected. Return to the Home Screen and restart therapy.
Bluetooth not turned on	The light panel is not hanging correctly. Ensure Solius is hanging vertical, fully opened, and level, then try to restart therapy.
Device software update failed	The device software update has failed. Turn Solius OFF and back ON, and then retry updating your device software.











Error Screen	Solution
Adjust Solius glasses and room lighting	<p>Your protective eyewear could not be verified.</p> <ul style="list-style-type: none">• Center the face in the frame.• Ensure Solius glasses fully cover both eyes with no glare or reflections in the glasses.• Use even lighting and avoid direct light into the camera.
Measurement has stopped	<p>Skin measurement has stopped. Ensure:</p> <ul style="list-style-type: none">• Measurement cone is securely attached.• Cone opening is fully covered.• Skin measured is a flat area on back (avoid spine) or inner forearm.• Area is free of hair, tattoos, or birthmarks.• Area is free of clothing or other obstructions. <p>Keep skin pressed against cone and press “Resume measurement” to try again.</p>
Emergency stop button engaged	<p>Emergency stop button must be disengaged in order to start therapy. Turn the red emergency stop button on top of the device clockwise until the button pops back up, then try again.</p>











Glossary of Symbols

Glossary of Symbols

Below is a list of symbols you will see throughout the User Manual and on the Solius Light Panel labels. They show proper and safe use of the device. You may also reference the symbols glossary at solius.com/symbols.

Below is a list of each symbol and its meaning.

Symbol	Meaning
	Caution.
	Warning; Optical radiation.
	Eye protection must be worn.
	Do not stare at light source.
	Medical device.
	MR (magnetic resonance) unsafe.
	Serial number.
	Catalogue number.
	Manufacturer.
	Date of manufacture.
	Unique device identifier.

Symbol	Meaning
	Power/ stand-by.
	Emergency stop.
	Refer to instruction manual.
	Class II equipment.
	Type BF applied part.
	Keep dry.
	Temperature limit.
	Humidity limit.
	Transportation.
	Storage.

Solius Light Panel Labels

Frequently Asked Questions

Frequently Asked Questions

What should I do if the Bluetooth is not connecting?

Make sure the device is plugged in to power, turned on, Bluetooth is active on your mobile device, and that you are near the Solius Light Panel. If any of these conditions are not met, the device will not connect to Bluetooth.

Do I need to wear eyewear? The light does not seem bright.

Yes! The Solius Light Panel UVB therapy light is invisible but can cause serious damage to the eyes if eyewear is not worn properly for the full duration of therapy.

If the light is invisible, how do I know the device is on during therapy?

There are visible colored lights at the top of the Solius Light Panel to show the device status. When the UVB light is on, the visible lights will turn yellow. The Solius Light Panel is equipped with sensors to ensure the therapy lights turn on as intended. If anything is wrong with your device, the device will go into error mode.

Will the Solius Light Panel have an affect on tattoos?

The Solius Light Panel will not have an effect on tattoos. You do not need to apply sunscreen to tattoos before using the Solius Light Panel, because UVB light does not penetrate the skin deeply enough to affect any tattoos.

How is the Solius Light Panel different than a tanning bed?

Using the Solius Light Panel will not tan your skin. Tanning occurs when UVA rays trigger melanocytes to produce melanin, the brown pigment that leads to tan skin. These UVA rays cause damage to the deep layers of the skin, which can lead to premature skin aging and skin cancer. The Solius Light Panel has isolated a narrow spectrum of UVB light that triggers vitamin D production at the very surface of the skin while excluding those harmful UVA rays.

Are there any instances where I should not use the Solius Light Panel?

Do not use the Solius Light Panel if you have any of the contraindications for use listed in the **Safety Information** page of the User Manual. Do not use the Solius Light Panel if the therapy area was exposed to a significant amount of sunlight in the past 24 hours, or you are experiencing any skin pinkness, redness, or irritation from a previous therapy or natural sun exposure. Using the Solius Light Panel in these cases may increase risk of skin damage or irritation.

My app says it is connected to the device, but the device lights didn't turn blue. What do I do?

Your app may have connected to another device in the area. Force quit the app, move your mobile device closer to your Solius Light Panel, and try connecting again.

Maintenance and Cleaning

Maintenance and Cleaning

Cleaning

To clean the Solius Light Panel and accessories:

1. Unplug the Solius Light Panel from the external power.
2. Gently wipe the surface using a dry cloth.
3. Visually inspect the surface to verify it is clean. Repeat cleaning steps 1–2 until the surface passes a visual inspection.

If cleaning cannot be completed with a dry cloth, use a water-dampened cloth or pre-saturated 70% IPA wipes instead of a dry cloth and follow steps 1–3.

Do not allow liquid to drip through any seams of the device while cleaning, and use a dry cloth to remove any residual moisture.

Clean the Solius Light Panel and accessories between users and as needed.



Do not:

- Use any abrasive cleaning agent or material on any surface.
- Spray or apply liquids directly to the device.
- Use window cleaner or other chemical cleaners on the device.
- Use solvents such as acetone, gasoline, benzene, pure alcohol, carbon tetrachloride, or lacquer thinner.
- Clean while the light panel is powered ON or in use.



Storage

When not in use, disconnect the Solius Light Panel from power by unplugging the device. Do not set up, use, or store the Solius Light Panel in areas exposed to direct sunlight or water. Ensure the device is used and stored in a clean, pest-free environment. Keep the device clean and free of dust or lint, as these can affect proper function over time. Insects or small animals may be attracted to light or heat and can interfere with device performance or pose a hygiene risk.

In case of damage to the skin sensor

If the glass covering the skin sensor on the front of the Solius Light Panel becomes scratched or cracked, do not use the light panel and contact Solius Customer Service.

Disposal

Check your local regulations and dispose of the Solius Light Panel through a certified electronic waste recycling center or a retailer with an electronic recycling program.

Technical Specifications

Technical Specifications

ETL CLASSIFIED



Intertek
5035116
M.E.E.

Model: Solius Pro

Solius has been designed and tested to be compliant with medical device standards and requirements of applicable regulatory agencies.

Operating Conditions	<p>Temperature: 0° C to 45° C Humidity: 15% to 90%, non-condensing but not requiring a water vapor partial pressure greater than 50 hPA Atmospheric Pressure: 700 hPa to 1060 hPa</p>
Maximum Operating Altitude	10,000 ft (3,000 m)
Transport Conditions	<p>Temperature: -25° C to 70° C Humidity: 15% to 90%, non-condensing Atmospheric Pressure: 700 hPa to 1060 hPa</p>
Storage Conditions	<p>Temperature: 0° C to 50° C Humidity: 15% to 90%, non-condensing but not requiring a water vapor partial pressure greater than 50 hPA Atmospheric Pressure: 700 hPa to 1060 hPa</p>
Device Dimensions	20" X 24" X 2" (508 mm X 610 mm X 51 mm)
Device Weight	Approximately 7 lb (3.18 kg)
Rated Input	100–240V~, 50/60 Hz, 70 VA (Works worldwide)
Useful Life	Up to 10 years

Applied Part Type	Type BF
Device 60601 Classification	Class II
NRTL Certified Safety Standards	IEC 60601-1: Electrical Safety IEC 60601-1-2: Electromagnetic Compatibility (EMC) IEC 60601-1-6: Usability IEC 60601-1-11: Home Healthcare Environment IEC 60601-2-57: Medical Light Therapy IEC 60601-2-83: Home Medical Light Therapy
UV Exposure Safety Guidelines	Solius Pro is below the Threshold Limit Values (TLV) for daily Ultraviolet Radiation (UV) exposure established by American Conference of Governmental Industrial Hygienists (ACGIH) Threshold Limit Values (TLV) 2024 for ultraviolet radiation (UV).
Cybersecurity	Compliant with IEC 81001-5-1: Health Software
Device Use Case	Multiple users, multiple use
95% of Emitted Wavelength Range	280 to 315 nm
Erythemally Weighted Irradiance	176 $\mu\text{W}/\text{cm}^2$ - 264 $\mu\text{W}/\text{cm}^2$ at 178 mm with 10% accuracy* *This represents essential performance
Maximum Output Measured at the Treatment Area	389 $\mu\text{W}/\text{cm}^2$
Output Uniformity	+/- 20% according to IEC 60601-2-57
Ocular Hazard Distance	11.5ft (3.5m)

<p>Equipment Classification</p>	<p>Risk Group 3: WARNING: UV emitted from this device may be hazardous. Avoid non-intended skin exposure and avoid eye exposure.</p> <p>The Solius Pro system addresses this risk through multiple independent, redundant, and enforced safety measures designed to mitigate the possibility of unprotected ocular exposure in the home environment.</p>
<p>FCC ID</p>	<p>Contains X8WBM832</p>
<p>Spectral Irradiance and Distribution</p>	<p style="text-align: center;">Typical Spectral Distribution</p>

Photosensitizing Agents

Photosensitizing Agents



WARNING: Using the Solius Light Panel while using one of these agents orally or topically on the therapy area may increase your risk for irritation. Consult your physician if you are unsure.

Acne

Antiarrhythmic.
Benzoyl peroxide.
Disopyramide.
Isotretinoin.
Quinidine sulfate.
Quinidine gluconate.

Anticancers

Afatinib.
Capecitabine.
Cetuximab.
Dacarbazine.
Dasatinib.
Tyrosine kinase inhibitor.
Erlotinib.
Farmorubicin.
Fluorouracil (5-FU).
Flutamide.
Gefitinib.
Hydroxyurea.
Imatinib.
Lapatinib.
Levulan.
Mesna.
Metvix.
Paclitaxel.
Panitumumab.
Photofrin.
Vandetanib.
Visudyne and others.
Tegafur-Uracil (UFT).
Vemurafenib.
Vinblastine.

Antidepressants / Antianxiety

Alprazolam.
Amitriptyline.
Amoxapine.
Chlordiazepoxide.
Citalopram.
Clomipramine.
Desipramine.
Doxepin.
Escitalopram.
Fluoxetine.
Fluvoxamine.
Imipramine.
Isocarbox acid.
Maprotiline.
Nortriptyline.
Paroxetine.
Phenelzine.
Protriptyline.
Sertraline.
Trazodone.
Trimipramine.
Venlafaxine.

Antihistamines

Cetirizine.
Cyproheptadine.
Dioxopromethazine.
Diphenhydramine.
Isothipendyl.
Mequitazine.
Ranitidine.
Trimeprazine.

Antihypertensives

Amlodipine.
Captopril.
Diltiazem.
Enalapril.
Indapamide.
Methyldopa.
Minoxidil.
Nifedipine.
Quinapril.
Ramipril.
Valsartan.

Anti-inflammatory / Antiarthritic

Azathioprine.
Celecoxib.
Diclofenac.
Diflunisal.
Gold Salts.
Hydrocortisone.
Ibuprofen.
Indomethacin.
Ketoprofen.
Leflunomide.
Mesalazine.
Nabumetone.
Naproxen.
Phenylbutazone.
Piroxicam.
Sulindac.
Tiaprofenic acid.

Antibiotics /Antifungals /Antimicrobials

Ciprofloxacin.
Chloramphenicol.
Cotrimoxazole.
Dapsone.
Demethylchlortetracycline.
Erythromycin.
Fleroxacin.
Griseofulvin.
Hexachlorophene.
Isoniazid.
Itraconazole.
Levofloxacin.
Lomefloxacin.
Lymecycline.
Methacycline.
Minocycline.
Moxifloxacin.
Nalidixic Acid.
Norfloxacin.
Ofloxacin.
Oxytetracycline.
Pefloxacin.
Pyrazinamide.
Sparfloxacin.
Sulfonamides.
Trimethoprim.

Antiparasitics

Bithionol.
Chloroquine.
Halogenated salicylanilides.
Ketoconazole.
Pyrvinium Pamoate.
Quinine.
Voriconazole.

Antipsychotics

Chlorpromazine.
Chlorprothixene.
Fluphenazine.
Flupentixol.
Haloperidol.
Olanzapine.
Perphenazine.

Piperacetazine.
Prochlorperazine.
Promethazine.
Thioridazine.
Thioxanthene.
Thiothixene.
Trifluoperazine.
Trifluopromazine.
Cholesterol-lowering
Atorvastatin.
Clofibrate.
Fenofibrate.
Pravastatin.
Simvastatin.

Contraceptives / Estrogens

Acetazolamide.
Amiloride.
Bendroflumethiazide.
Benzthiazide.
Chlorothiazide.
Chlorotrianisene.
Cyclothiazide.
Diethylstilbestrol.
Diuretics.
Estradiol.
Estrogens, conjugated and
esterified.
Ethinyl estradiol.
Furosemide.
Hydroflumethiazide.
Medroxyprogesterone.
Megestrol.
Metolazone.
Norethindrone acetate.
Polythiazide.
Quinethazone.
Thiazides.
Triamterene.
Trichlormethiazide.

Hypoglycemics / Antidiabetics

Acetohexamide.

Chlorpropamide.
Glibenclamide.
Glipizide.
Glyburide.
Sitagliptin.
Sulfonylureas.
Tolazamide.
Tolbutamide.

Oils (perfumes / cosmetics)

Bergamot.
Citron.
Citrus rind.
Lavender.
Lemon.
Lime.
Musk ambrette.
Sandalwood cedar.
Psoriasis coal tar.
Desoximetasone.
Etretinate.
Methoxsalen.
Psoralens.
Trioxsalen.

Others

6-methylcoumarin
(perfumes, shaving lotions, and
sunscreens).
Amantadine.
Avobenzone.
Benzocaine.
Benzophenones.
Carbamazepine.
Cinnamates.
Clopidogrel.
Eculizumab.
Efavirenz.
Fluorescein.
Homosalate.
Hydroxychloroquine.
Oxybenzone.
PABA esters.
Para-aminobenzoic acid.
Pirfenidone.
Pyridoxine (vitamin B6).

Cybersecurity and Use Guidelines

Cybersecurity and Use Guidelines

This section provides important information for protecting the Solius system and its users from cybersecurity-related risks. It supports safe and secure use of the Solius Light Panel and the mobile app.

Communication and connections

The Solius Light Panel connects via Bluetooth Low Energy (BLE) to the Solius mobile app installed on a user's mobile device. Once paired, all therapy commands are issued from the app, and status indicators are returned via BLE.

The mobile app also connects to Solius Cloud services over HTTPS using TLS 1.2/1.3 encryption.

This secure cloud connection is used to:

- Create and manage user accounts.
- Store therapy history.
- Notify users about software updates.
- Support remote updates to the Solius Light Panel device software.

The Solius Light Panel does not connect directly to Wi-Fi or the internet.

Interfaces and data flow

The following digital communication interfaces are used within the Solius System.

Interface	Direction	Function	Notes
BLE (Bluetooth)	Bidirectional	Therapy commands and device status updates	Local only, pairing required
HTTPS (via app)	Bidirectional	Cloud account setup, therapy history, updates	TLS 1.2/1.3; user must be online during setup

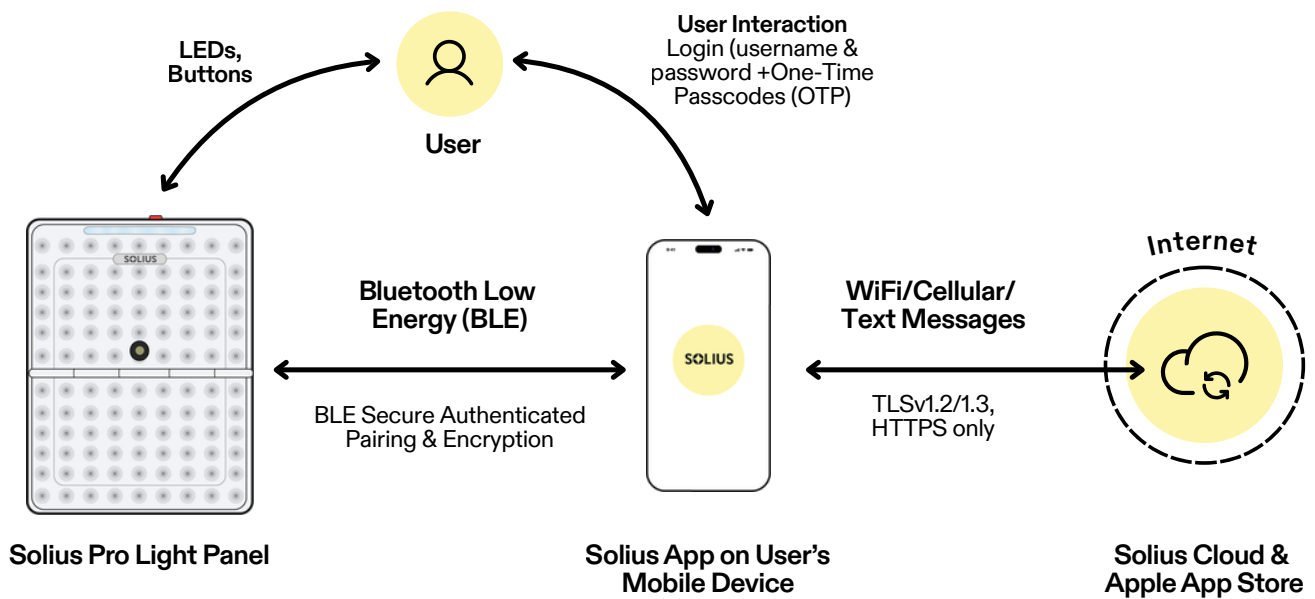

Secure use expectations

- **User Account Protection:** Each user must create a Solius account with a unique password. Optional biometric login is available through supported iOS features.
- **App Access Controls:** The app enforces lockouts and dose limits based on reported skin reactions to prevent unsafe use.
- **Device Protection:** The light panel includes emergency stop functionality and a proximity sensor that automatically pauses therapy if the user moves too close or too far from the panel.
- **Secure Updates:** Firmware updates are digitally signed and delivered via the mobile app. Update availability is communicated in-app. The app must be online to perform a device software update.
- **Error Handling:** If abnormal conditions occur (e.g., device overheating, pairing issues), the app displays error messages and instructs the user on corrective action. Some events also trigger device beeps and status light changes.
- **Logging and History:** Therapy sessions, dose durations, device version, and status codes are logged in the app. Users can review past sessions from the **Therapy History** page.
- **Backups and Recovery:** Therapy profiles and history are linked to the user's Solius account. Reinstalling the app or switching devices allows recovery after logging back in.

Secure configuration and decommissioning

Users should always download the mobile app from the Apple App Store and use it only on a device with up-to-date operating system security patches. The light panel and mobile app are preconfigured to enforce secure defaults, including app-to-device pairing and data encryption.

If the Solius Light Panel is no longer in use, users should:

- Delete their Solius account from the **Profile** tab of the mobile app.
- Uninstall the app from their mobile device.
- Recycle the device at an approved electronics recycling center (see disposal instructions of this manual).

For technical support, to report an issue, or to request a software bill of materials (SBOM), contact support@solius.com.

EMC Declaration

EMC declaration

The Solius Light Panel is suitable for use in a home healthcare environment and facilities. The customer or the user of the Solius Light Panel should ensure it is used in such an environment. This device includes a (BLE) transmitter operating in the 2.4 GHz ISM band (2402 MHz to 2480 MHz) using GFSK modulation with a modulation index of 0.5. The effective radiation power (ERP) is ≤ 10 dBm.

Other places might have signals that can affect the Solius Light Panel. These places include doctors' offices, dental offices, clinics, hospitals, military areas, and heavy factories.

If the Solius Light Panel is affected by electromagnetic disturbances, the user interface may not function, therapy lights may turn on or off prematurely, or the Solius Light Panel may transition into error mode. If this happens, please stop using the Solius Light Panel and contact customer service.



WARNING: Use of this equipment adjacent to or stacked with other equipment should be avoided because it could result in improper operation. If such use is necessary, this equipment and the other equipment should be observed to verify that they are operating normally.

WARNING: Only use the parts (like cords and other items) that come with this device or are made by Solius. Using other parts could cause signal problems or make the device work poorly.

WARNING: Keep portable radios and phones (and their parts, like antenna cables) at least 12in (30cm) away from the Solius Light Panel. This includes any cords from the Solius Light Panel.

Electromagnetic emission

Standard	Description	IEC60601-1-2:2020 Compliance Level	IEC60601-1-2:2020 Test Level
Cispr 11/EN55011	Radiated RF Emissions	Group 1, Class B	Group 1, Class B
Cispr 11/EN55011	Conducted RF Emissions	Class B	Class B
IEC61000-3-2	Harmonics	Class A	Class A
IEC61000-3-3	Flicker	Complies	Complies

Electromagnetic immunity

Notes:
 * IEC 61000-4-11 Line Voltage dropout tests may result in unit shutdown that requires user to restart device

Standard	Description	IEC60601-1-2:2020 Compliance Level	IEC60601-1-2:2020 Test Level
IEC61000-4-2	ESD	± 2 kV, ± 4 kV, ± 8 kV, ± 15 kV air ± 8 kV contact	± 2 kV, ± 4 kV, ± 8 kV, ± 15 kV air ± 8 kV contact
IEC61000-4-3	Radiated RF Immunity	80-2700 MHz: 10 V/m, 80% AM, 1 kHz 385 MHz: 27 V/m, PM, 18 Hz 450 MHz: 28 V/m, FM+/-5 kHz dev, 1 kHz 710, 745, 780 MHz: 9 V/m, PM, 217 Hz 810, 870, 930 MHz: 28 V/m, PM, 18 Hz 1720, 1845, 1970 MHz: 28 V/m, PM, 217 Hz 2450 MHz: 28 V/m, PM, 217 Hz 5240, 5500, 5785 MHz: 9 V/m, PM, 217 Hz	80-2700 MHz: 10 V/m, 80% AM, 1 kHz 385 MHz: 27 V/m, PM, 18 Hz 450 MHz: 28 V/m, FM+/-5 kHz dev, 1 kHz 710, 745, 780 MHz: 9 V/m, PM, 217 Hz 810, 870, 930 MHz: 28 V/m, PM, 18 Hz 1720, 1845, 1970 MHz: 28 V/m, PM, 217 Hz 2450 MHz: 28 V/m, PM, 217 Hz 5240, 5500, 5785 MHz: 9 V/m, PM, 217 Hz
IEC61000-4-4	EFT Immunity	± 2 kV, 100 kHz PRR	± 2 kV, 100 kHz PRR
IEC61000-4-5	Surge Immunity	± 0,5 kV, ± 1 kV L1/L2	± 0,5 kV, ± 1 kV L1/L2
IEC61000-4-6	Conducted RF Immunity	3V rms 150 kHz - 80 MHz, 80% amplitude modulation at 1 kHz and 6 Vrms for ISM and amateur frequencies between 150 kHz-80 MHz	3V rms 150 kHz - 80 MHz, 80% amplitude modulation at 1 kHz and 6 Vrms for ISM an amateur frequencies between 150 kHz - 80 MHz
IEC61000-4-8	Magnetic Immunity	30 A/m, 60 Hz	30 A/m, 60 Hz
IEC61000-4-11	Low Voltage Immunity	=0 % UT for 0.5 cycle (at 50 Hz) At 0°, 45°, 90°, 135°, 180°, 225°, 270°, 315° =0 % UT for 1 cycle (at 50 Hz)* =70% UT for 25 cycles (at 50 Hz)* =0% UT for 250 cycles (at 50 Hz)*	=0 % UT for 0.5 cycle (at 50 Hz) At 0°, 45°, 90°, 135°, 180°, 225°, 270°, 315° =0 % UT for 1 cycle (at 50 Hz)* =70% UT for 25 cycles (at 50 Hz)* =0% UT for 250 cycles (at 50 Hz)*
IEC61000-4-39	Magnetic Immunity	30 kHz CW at 8 A/m 134.2 kHz, 2.1 kHz PM, 65 A/m 13.56 MHz, 50 kHz PM, 7.5 A/m	30 kHz CW at 8 A/m 134.2 kHz, 2.1 kHz PM, 65 A/m 13.56 MHz, 50 kHz PM, 7.5 A/m

Electrical Warnings and Cautions

Electrical warnings and cautions



WARNING: Do not leave the light panel alone when it is on. This can cause fire or burns.

WARNING: People with certain challenges should not use this device. This includes those with limited physical, sensory, or mental abilities. Also, those without enough experience or knowledge. They can use it only if someone watches them or teaches them how to use it safely. This helps avoid fire or burns.

WARNING: This equipment is not intended for use by children. Children should be supervised to ensure they do not play with the equipment to avoid the risk of fire and burns.

WARNING: If the power cord is damaged, contact Solius for a replacement to avoid risk of electrocution.

WARNING: Water and electricity are a dangerous combination! To avoid risk of electrocution, do not get device wet.

WARNING: Check if the voltage indicated on the equipment corresponds to the local power voltage before you connect the equipment to avoid risk of electrocution or permanent damage to the equipment.

WARNING: If the wall outlet you use for the device has bad connections, the plug will get hot. Make sure you plug the equipment into a properly installed wall socket to avoid the risk of fire and burns.



CAUTION: Do not subject the equipment to heavy shocks to avoid risk of damage to the light panel.

CAUTION: Always unplug the light panel after use and in case of a power failure to avoid risk of damage to the light panel.

CAUTION: UV emitted from this device. Eye or skin irritation may result.

CAUTION: Use of control or adjustments or performance of procedures other than those specified herein may result in hazardous radiation exposure.

SOLIUS[®]